	DESIGN & APPLICATION ENGINEERS S.A. ILEKTRAS 2 & KIMIS AVENUE, 15122 MAROUSSI TEL +30 (210)6412233, 2810122 FAX +30 (210)6454825 e-mail: civeng@mhxme.gr web: www.mhxme.com	Einzelheiten			
		DATUM	24/04/2026	Pg	

Panathinaikos FC New Stadium

Zeit-Studie	Budget (€)	Arbeitgeber
2008 - 2010	82.00	Aktor S.A.
	Besitzer	Position
	Panathinaikos FC	Votanikos, Athens

The new stadium has a capacity of 40.000 spectators, and the total of the grandstands is covered by the roof. The buildings housing the auxiliary installations are made of concrete and bear the stands' system, comprising of cast-in-situ beams and precast reinforced concrete stands. At each of the 4 corners, concrete pylons bear the steel roof, which is also supported on the perimeter columns of the grandstands' buildings.

The stadium has a circular shape with external diameter 211.00 m. The steel roof consists of 4 statically independent parts, each one resting on a simply supported main space-truss beam and on the perimeter columns. Each space-truss arch-shaped beam is supported on the concrete pylon. The span of the large beam is 160m and of the small 110m. The pylons are founded on piles while the concrete buildings have a strip foundation.



DESIGN & APPLICATION ENGINEERS S.A.
ILEKTRAS 2 & KIMIS AVENUE, 15122 MAROUSSI
TEL +30 (210)6412233, 2810122 FAX +30 (210)6454825
e-mail: civeng@mhxme.gr web: www.mhxme.com

Einzelheiten



DATUM

24/04/2026

Pg

2/15

Architectural 3d view





DESIGN & APPLICATION ENGINEERS S.A.
ILEKTRAS 2 & KIMIS AVENUE, 15122 MAROUSSI
TEL +30 (210)6412233, 2810122 FAX +30 (210)6454825
e-mail: civeng@mhxme.gr web: www.mhxme.com

Einzelheiten



DATUM

24/04/2026

Pg

3/15

Architectural 3d view

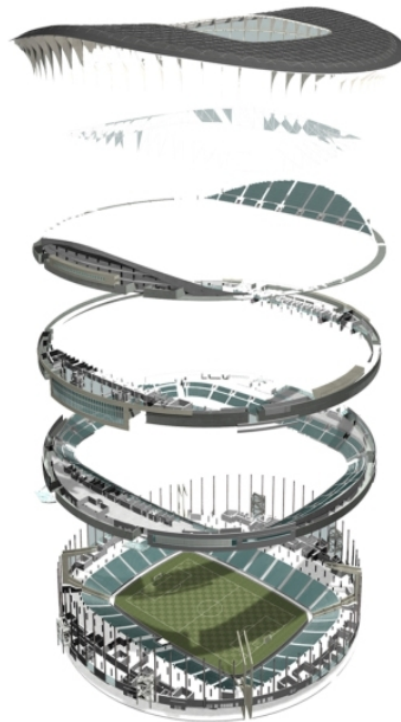
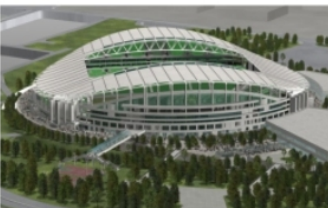



3d views of the stadium structural system

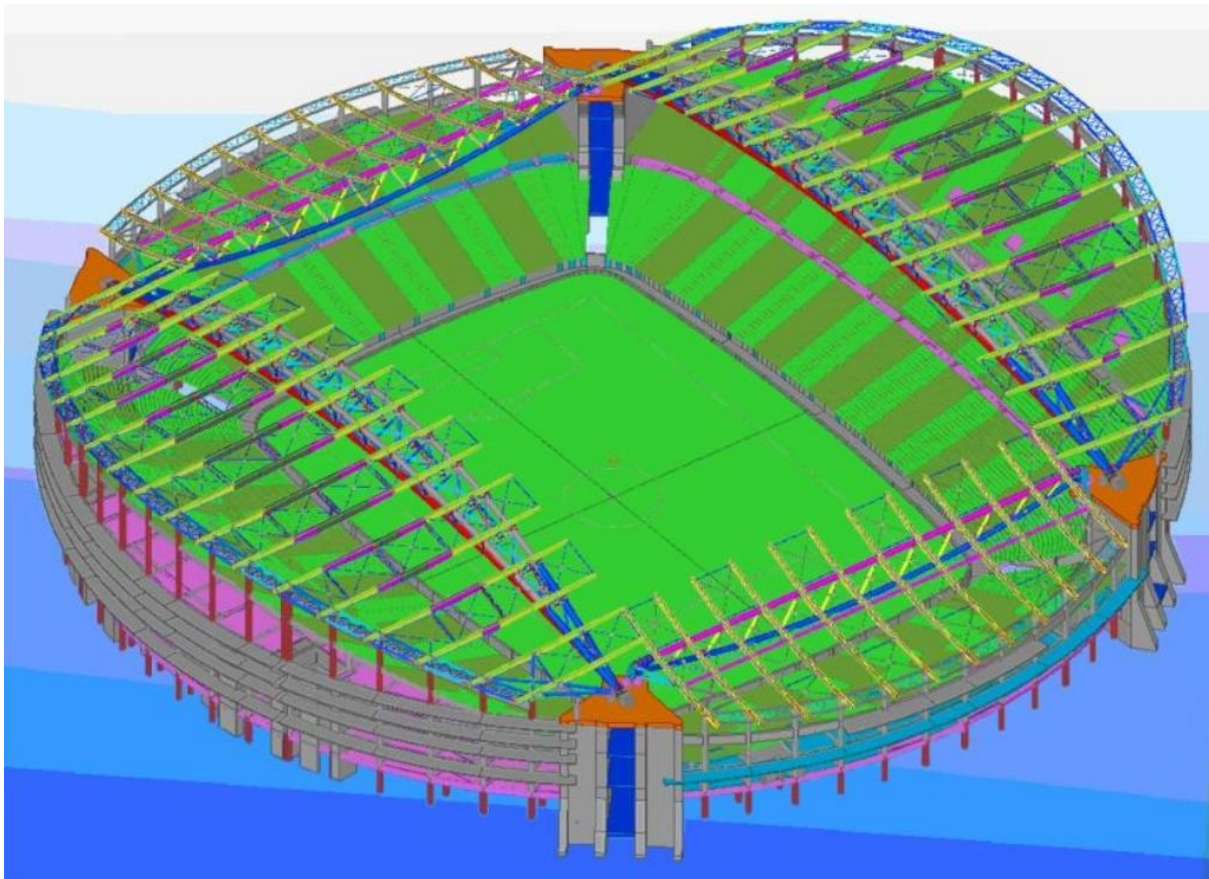



Sections of the structural system

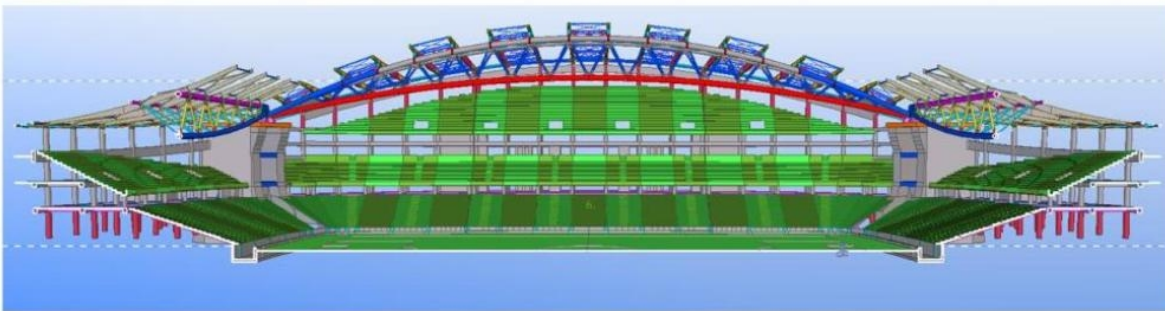
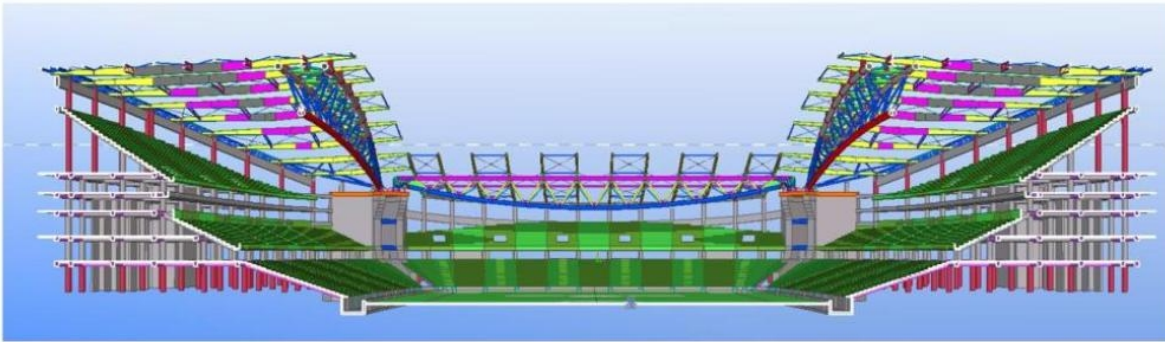



DESIGN & APPLICATION ENGINEERS S.A.
ILEKTRAS 2 & KIMIS AVENUE, 15122 MAROUSSI
TEL +30 (210)6412233, 2810122 FAX +30 (210)6454825
e-mail: civeng@mhxme.gr web: www.mhxme.com

Einzelheiten



DATUM

24/04/2026

Pg

6/15

Steel Roof General Arrangement

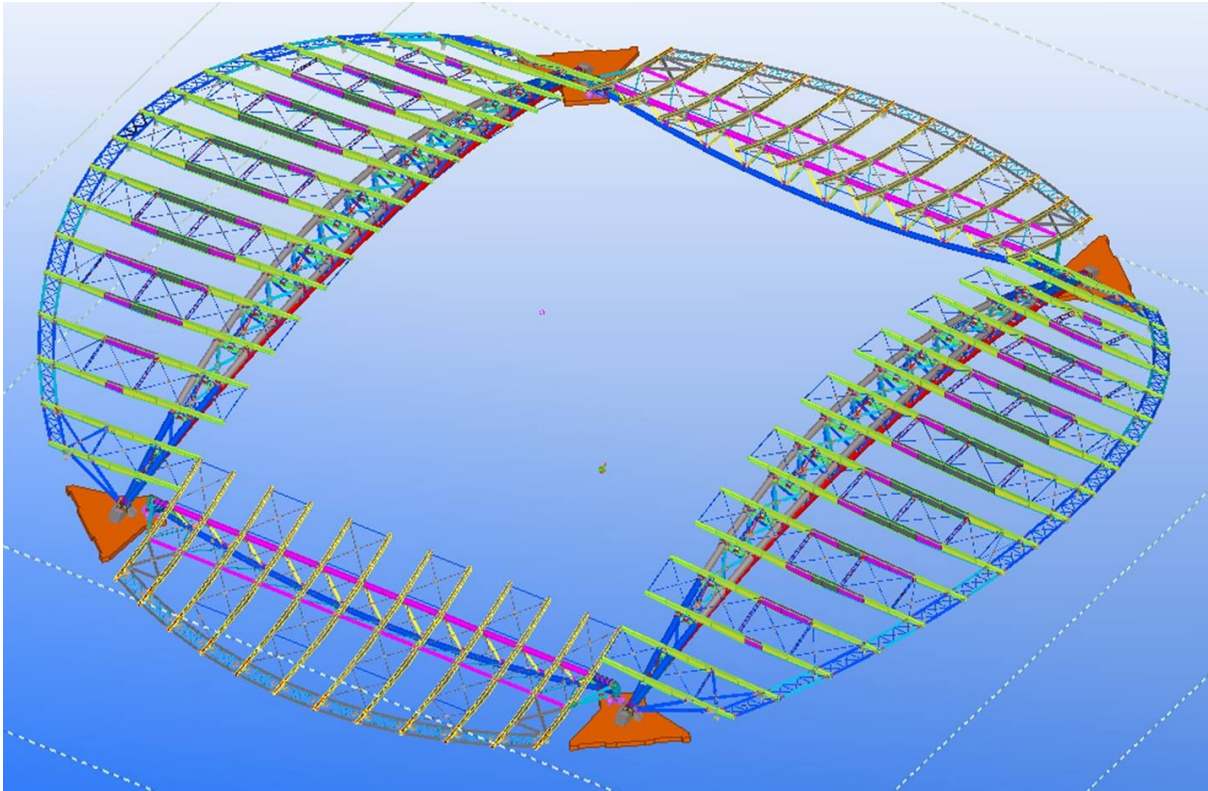



DESIGN & APPLICATION ENGINEERS S.A.
ILEKTRAS 2 & KIMIS AVENUE, 15122 MAROUSSI
TEL +30 (210)6412233, 2810122 FAX +30 (210)6454825
e-mail: civeng@mhxme.gr web: www.mhxme.com

Einzelheiten



DATUM

24/04/2026

Pg

7/15

Large Roof Structure General Arrangement

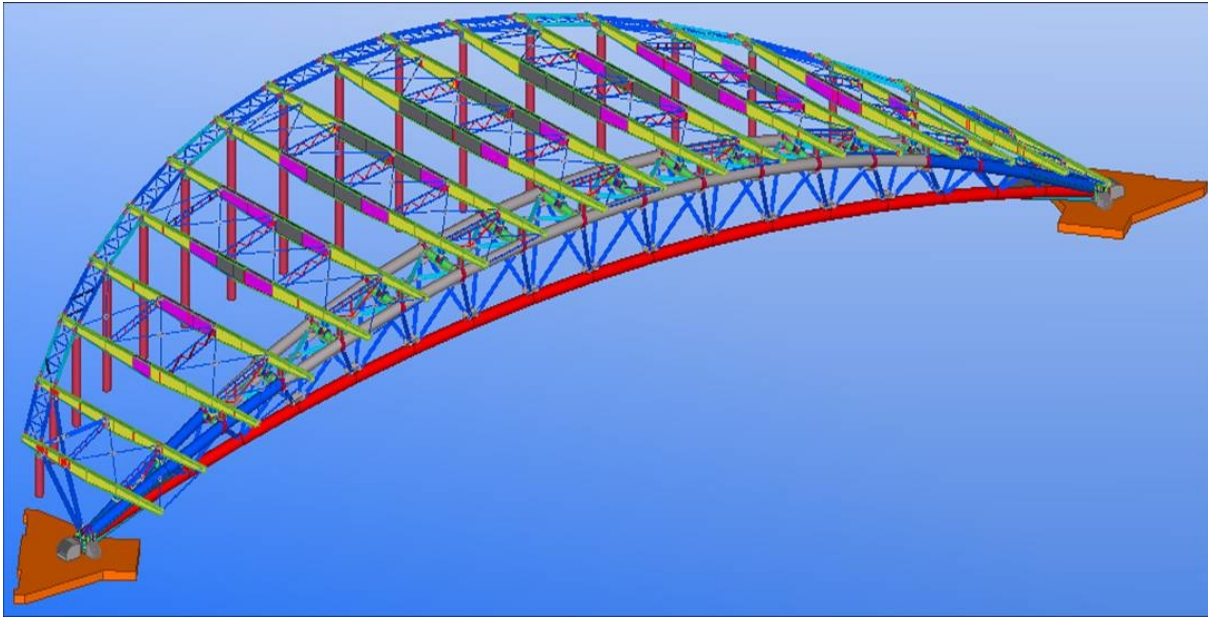



DESIGN & APPLICATION ENGINEERS S.A.
ILEKTRAS 2 & KIMIS AVENUE, 15122 MAROUSSI
TEL +30 (210)6412233, 2810122 FAX +30 (210)6454825
e-mail: civeng@mhxme.gr web: www.mhxme.com

Einzelheiten



DATUM

24/04/2026

Pg

8/15

Roof supports on pylons

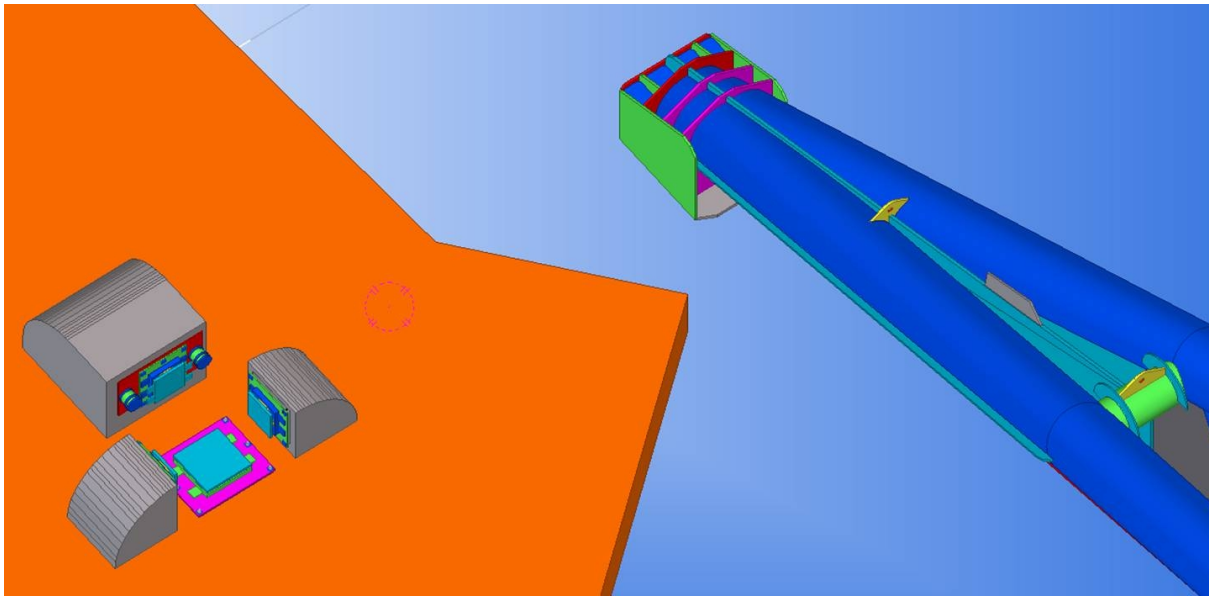



Support of Large and Small Trusses on pylon

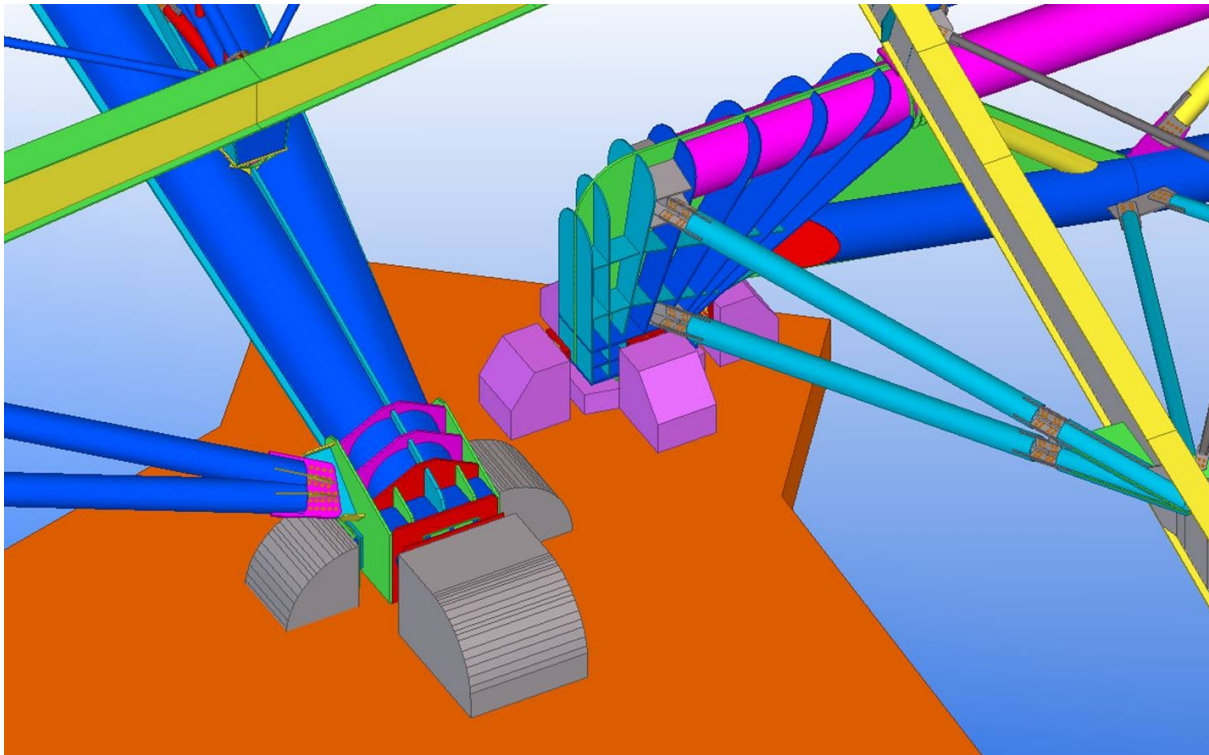



Connection of upper chord members

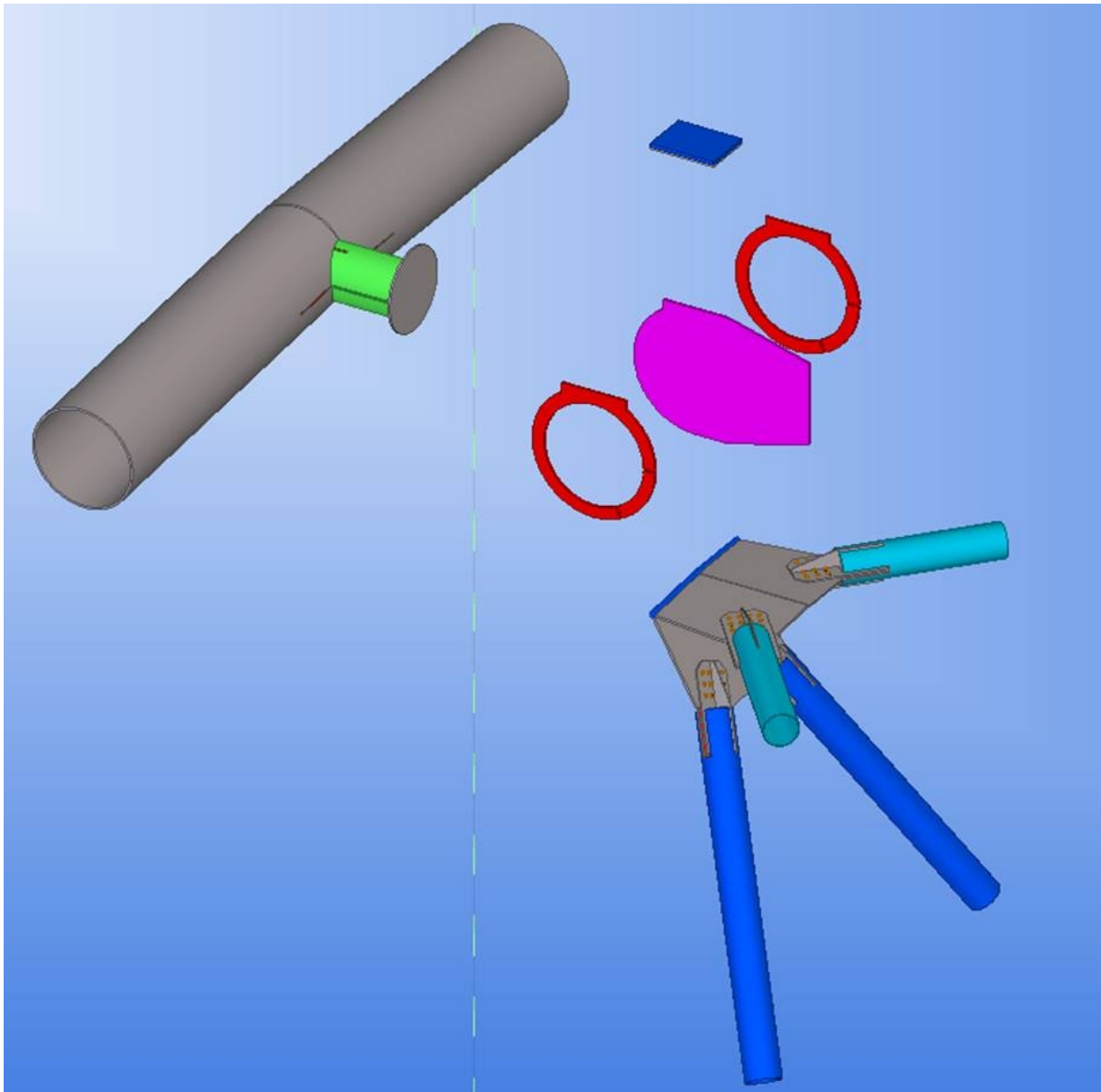



Support of main beam on the truss

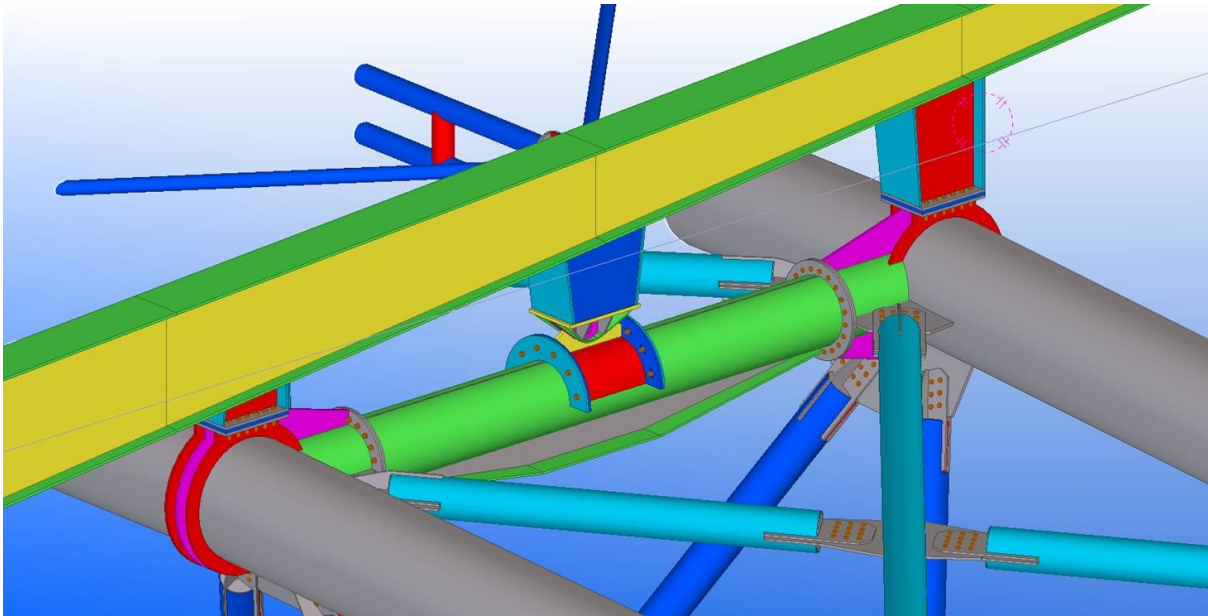



Support of main beams on the truss-Detail

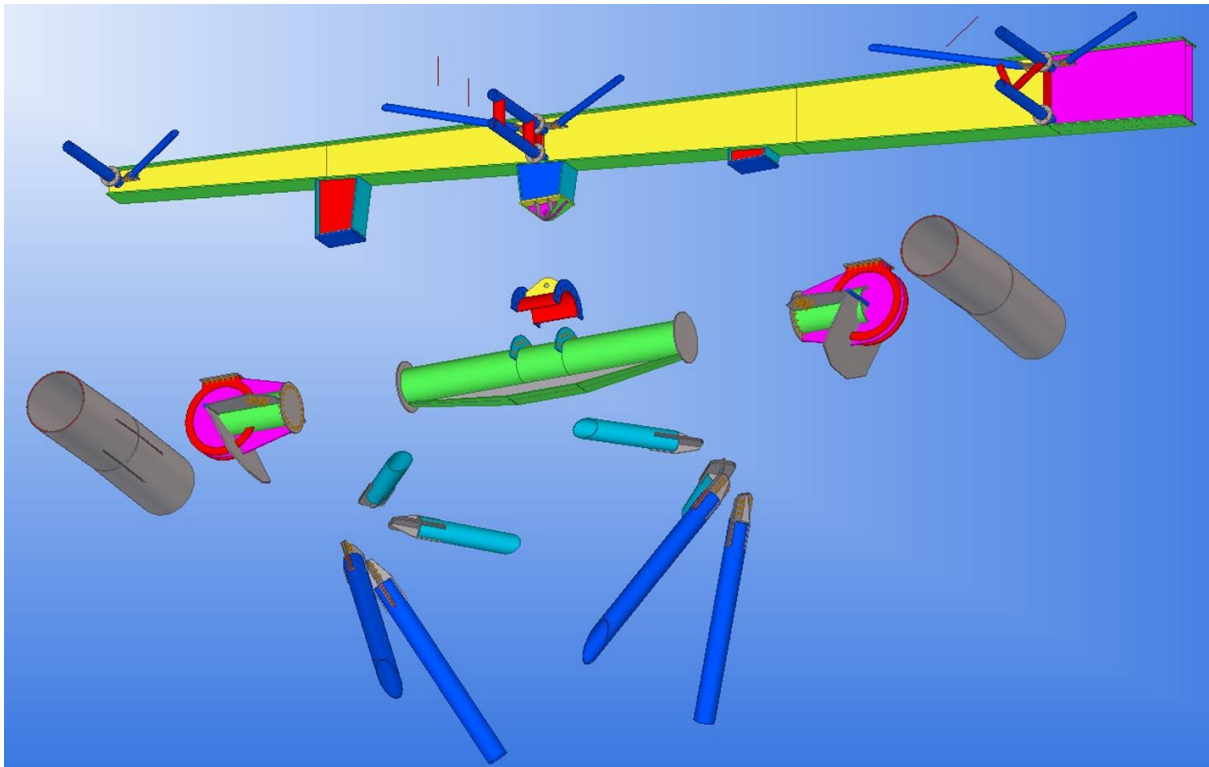



Support of main beam on the truss

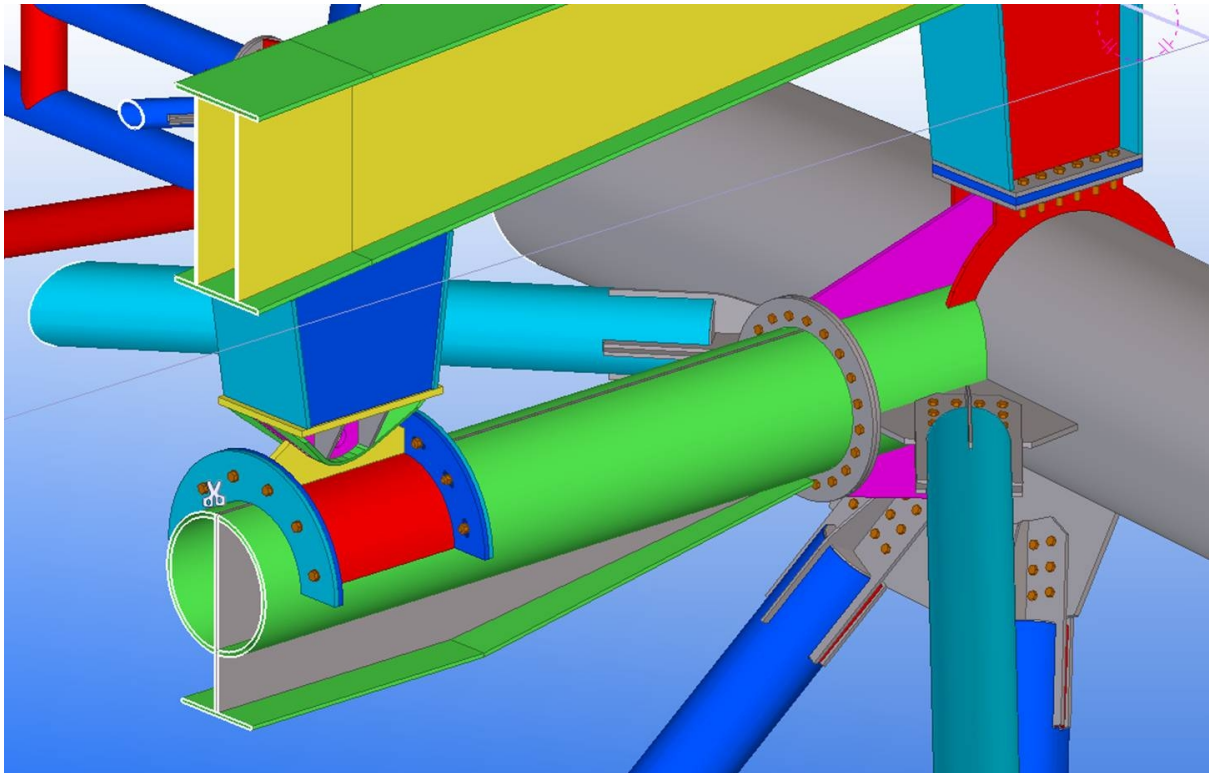



Steel Roof General Arrangement

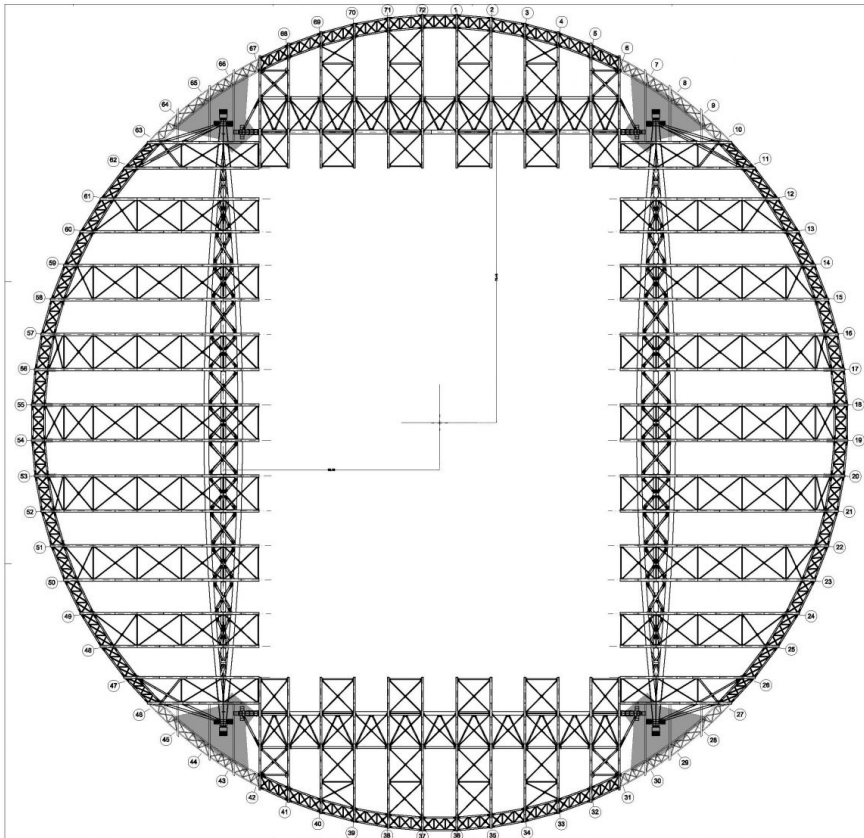



Sections

