	<b>DESIGN &amp; APPLICATION ENGINEERS S.A.</b> ILEKTRAS 2 & KIMIS AVENUE, 15122 MAROUSSI TEL +30 (210)6412233, 2810122 FAX +30 (210)6454825 e-mail: civeng@mhxme.gr web: www.mhxme.com	Einzelheiten			
		DATUM	03/07/2026	Pg	

### **New Panathinaikos FC Stadium**

<b>Zeit-Studie</b>	<b>Budget (€)</b>	<b>Arbeitgeber</b>
2008 - 2010	82,000,000.00	PANATHINAIKOS FC/ AKTOR SA
	<b>Besitzer</b>	<b>Position</b>
		ATHENS - VOTANIKOS AREA

The new stadium has a capacity of 40.000 spectators, and the total of the grandstands is covered by the roof. The buildings housing the auxiliary installations are made of concrete and bear the stands' system, comprising of cast-in-situ beams and precast reinforced concrete stands. At each of the 4 corners, concrete pylons bear the steel roof, which is also supported on the perimeter columns of the grandstands' buildings.

The stadium has a circular shape with external diameter 211.00 m. The steel roof consists of 4 statically independent parts, each one resting on a simply supported main space-truss beam and on the perimeter columns. Each space-truss arch-shaped beam is supported on the concrete pylon. The span of the large beam is 160m and of the small 110m. The pylons are founded on piles while the concrete buildings have a strip foundation.



**DESIGN & APPLICATION ENGINEERS S.A.**  
ILEKTRAS 2 & KIMIS AVENUE, 15122 MAROUSSI  
TEL +30 (210)6412233, 2810122 FAX +30 (210)6454825  
e-mail: civeng@mhxme.gr web: www.mhxme.com

Einzelheiten



DATUM

03/07/2026

Pg

2/15

*Architectural 3d view*





*Architectural 3d view*

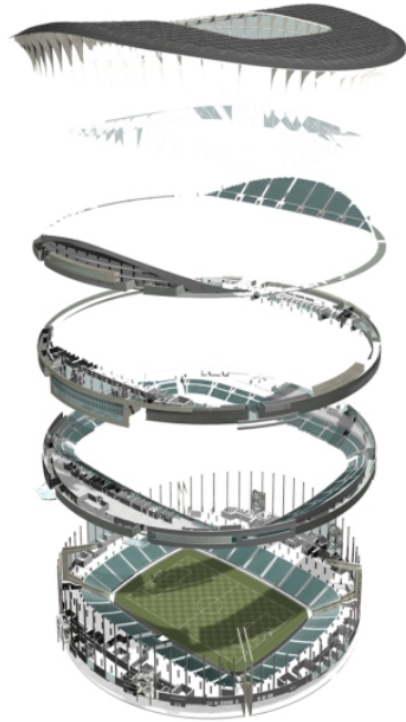
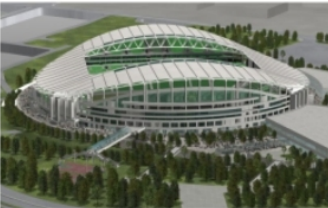
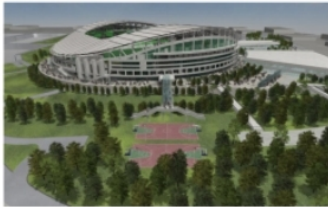
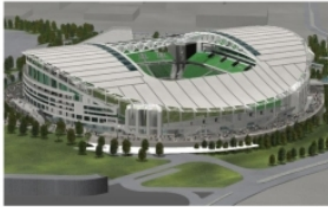



*3d views of the stadium structural system*

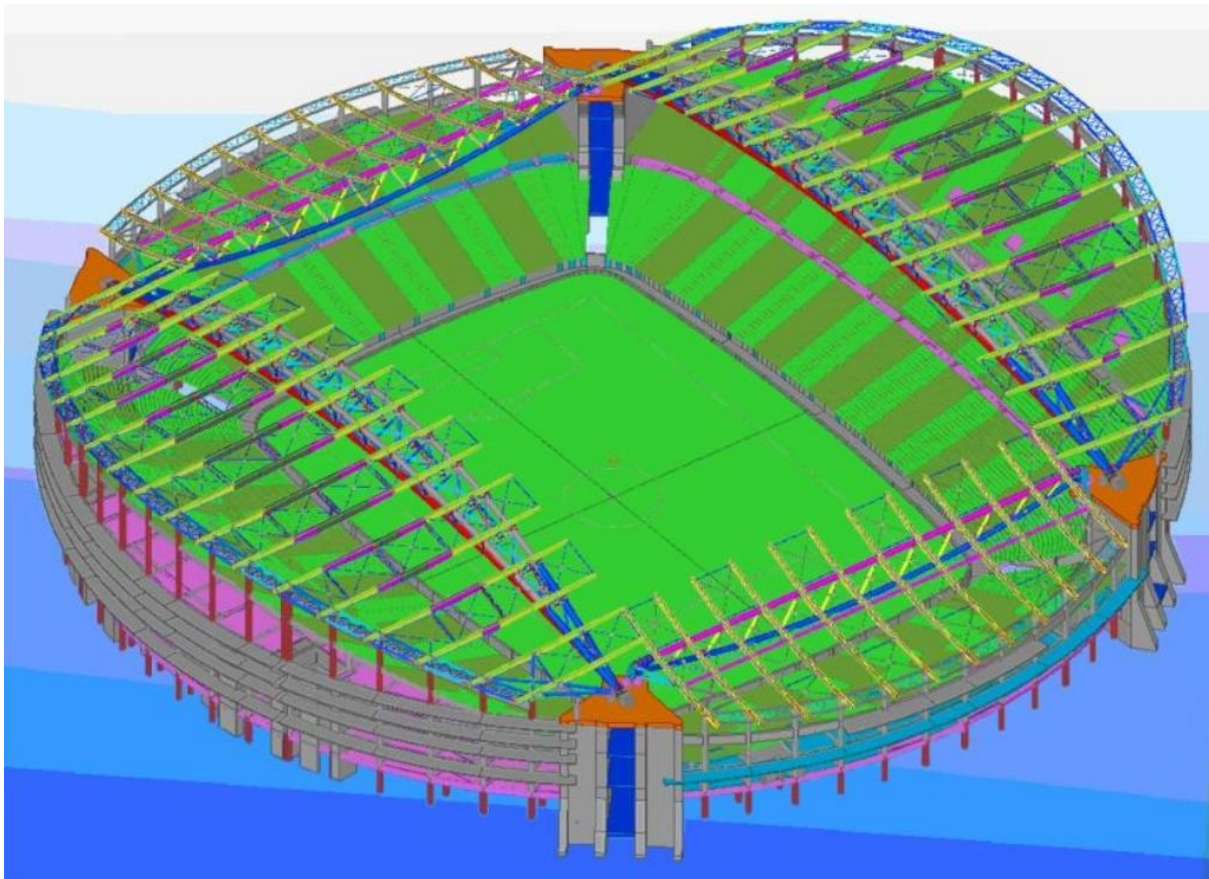



*Sections of the structural system*

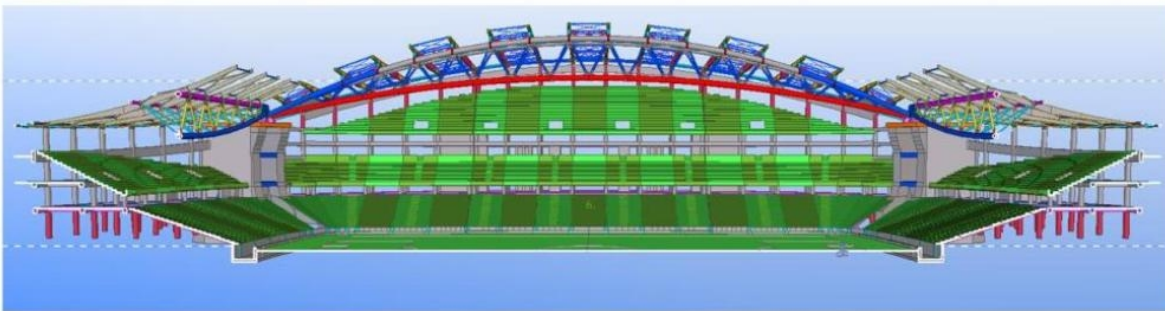
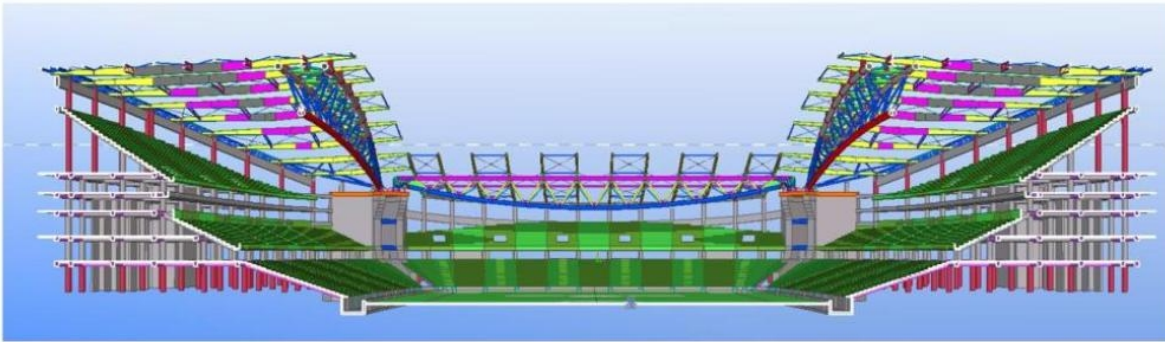



**DESIGN & APPLICATION ENGINEERS S.A.**  
ILEKTRAS 2 & KIMIS AVENUE, 15122 MAROUSSI  
TEL +30 (210)6412233, 2810122 FAX +30 (210)6454825  
e-mail: civeng@mhxme.gr web: www.mhxme.com

Einzelheiten



DATUM

03/07/2026

Pg

6/15

### Steel Roof General Arrangement

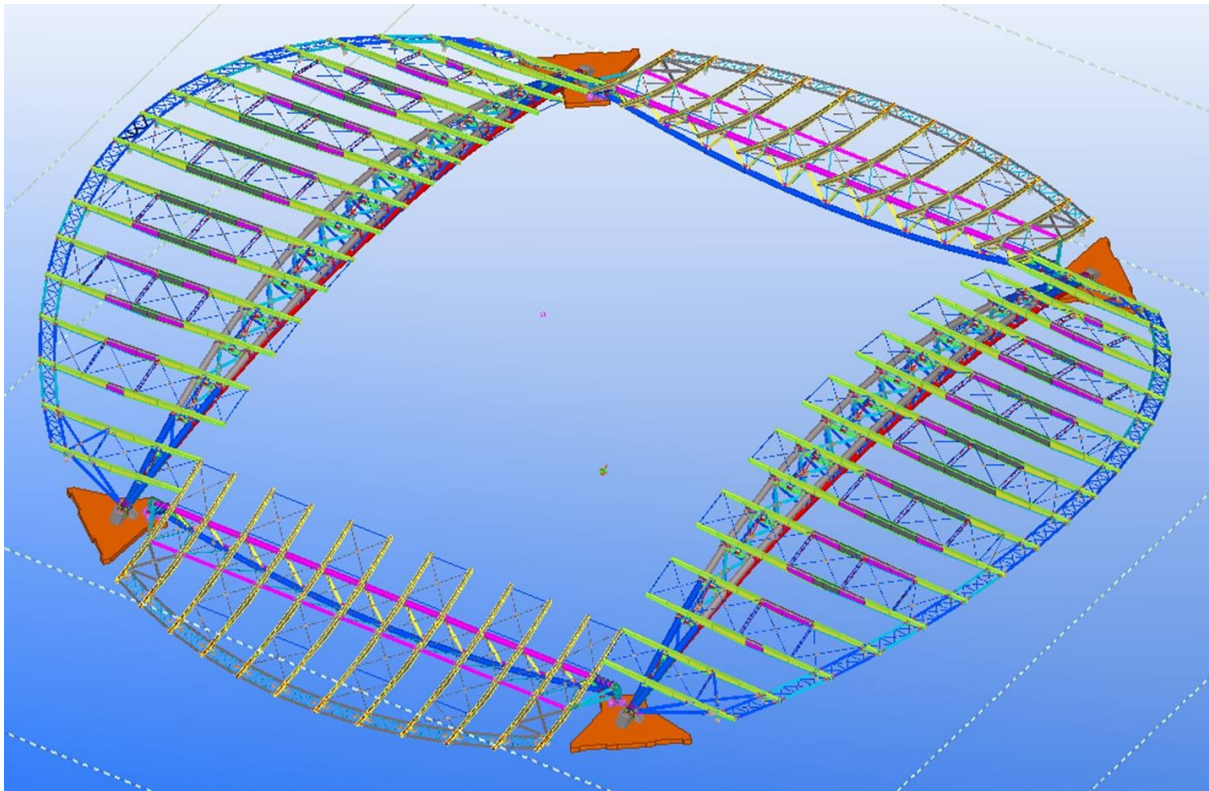



*Large Roof Structure General Arrangement*

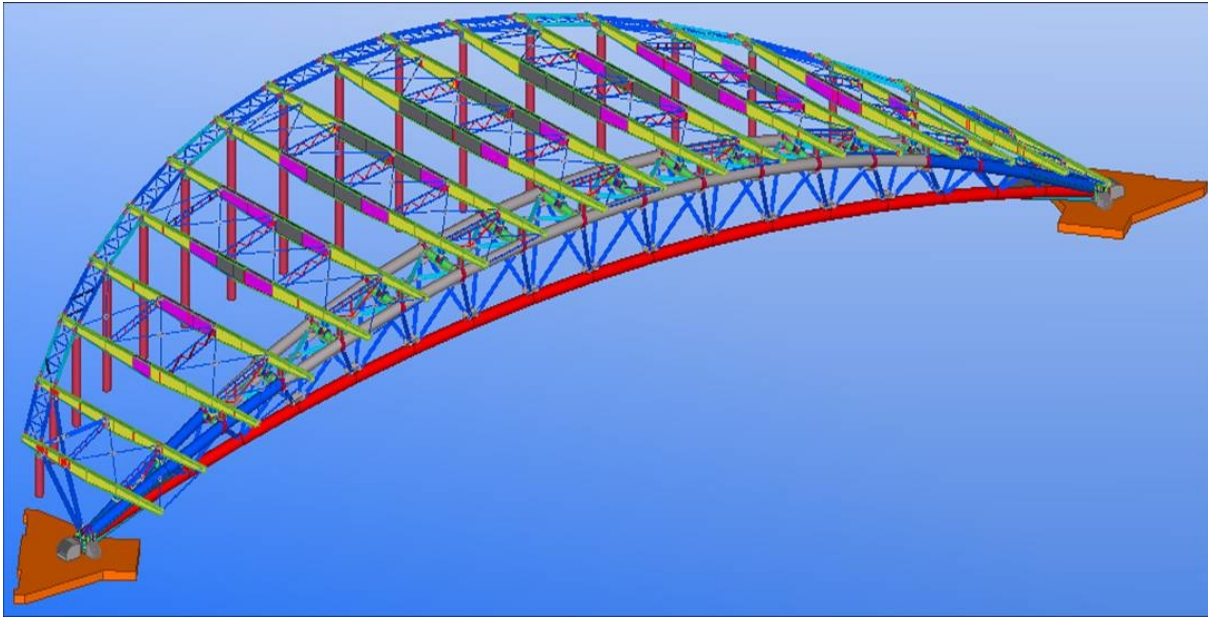



**DESIGN & APPLICATION ENGINEERS S.A.**  
ILEKTRAS 2 & KIMIS AVENUE, 15122 MAROUSSI  
TEL +30 (210)6412233, 2810122 FAX +30 (210)6454825  
e-mail: civeng@mhxme.gr web: www.mhxme.com

Einzelheiten



DATUM

03/07/2026

Pg

8/15

*Roof supports on pylons*

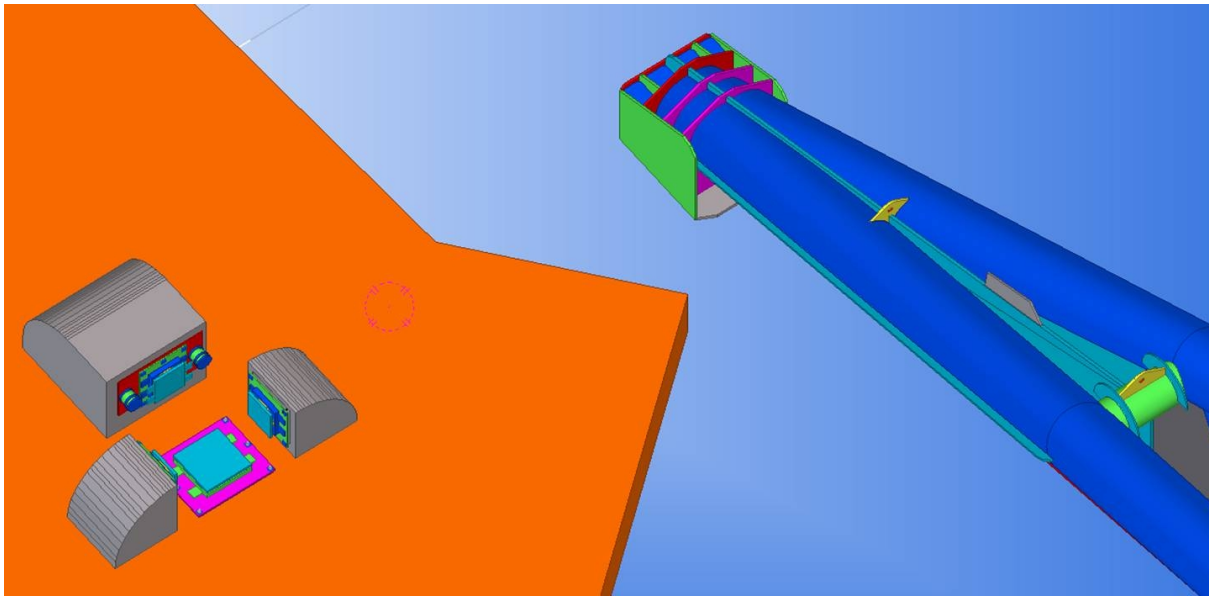



*Support of Large and Small Trusses on pylon*

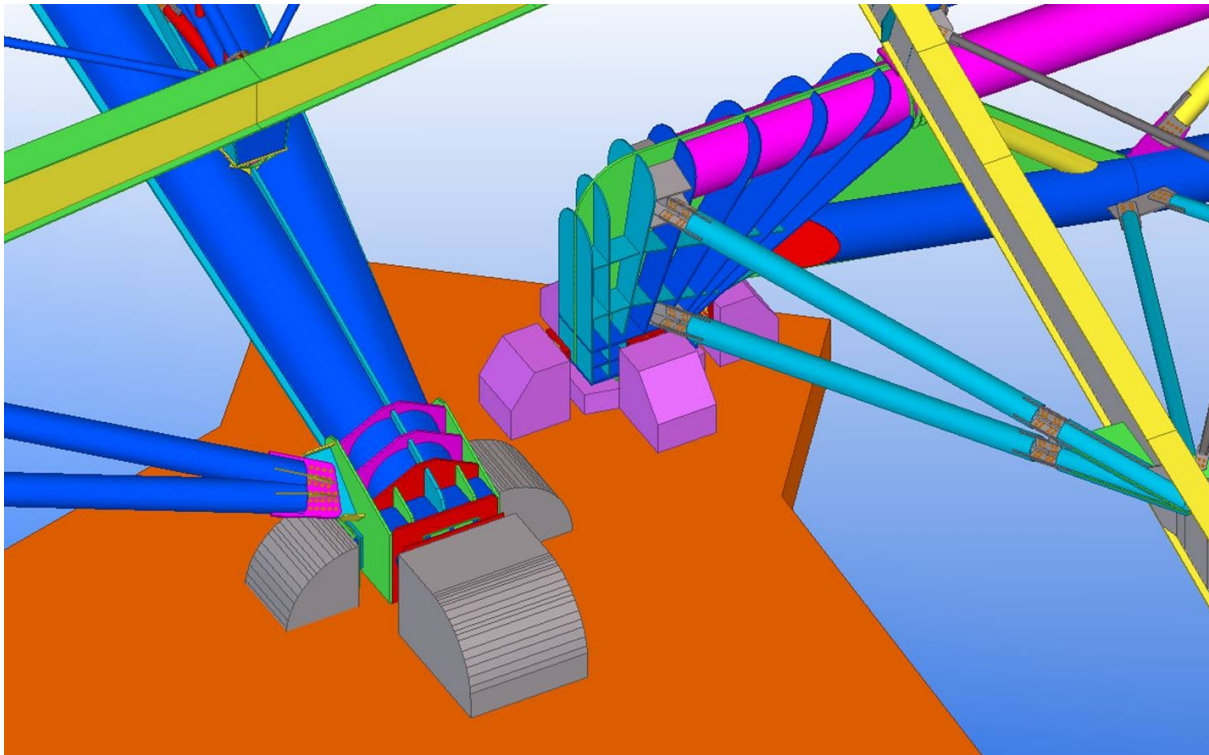



*Connection of upper chord members*

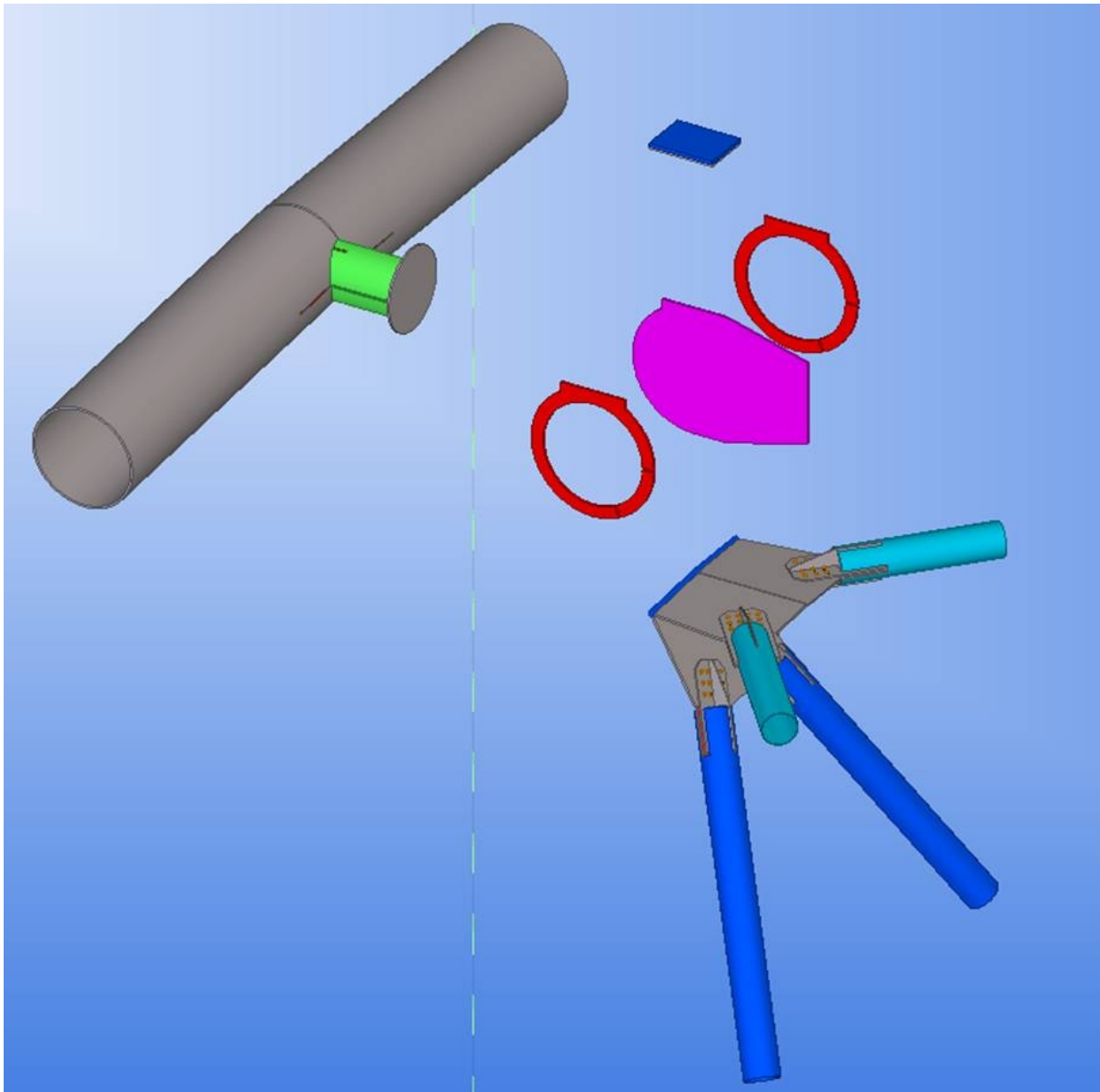



*Support of main beam on the truss*

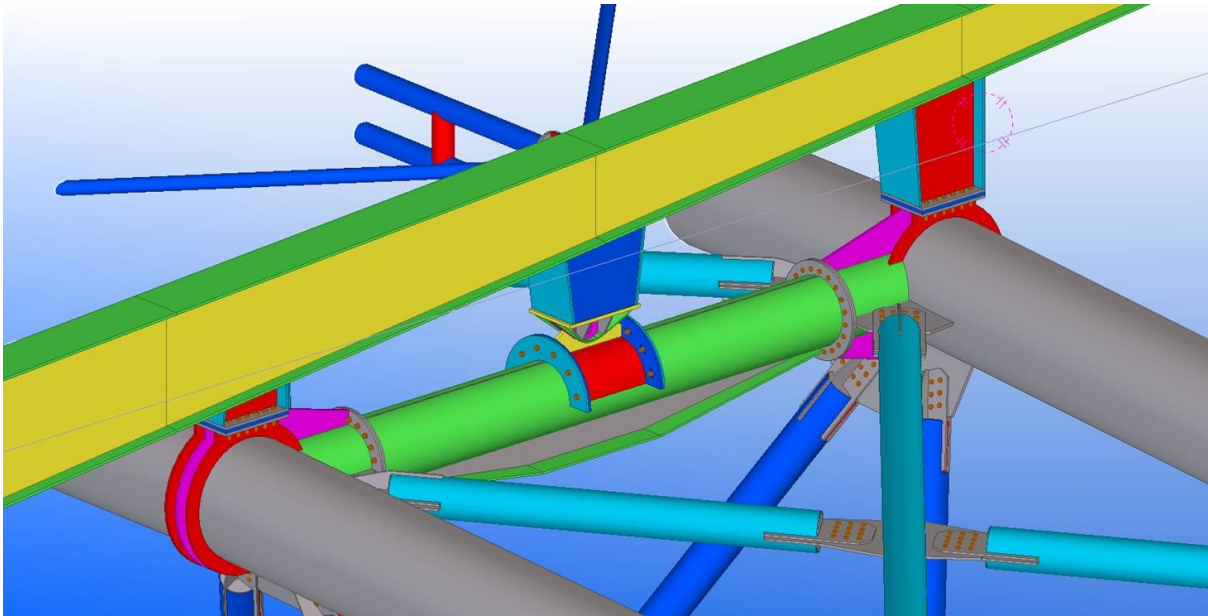



*Support of main beams on the truss-Detail*

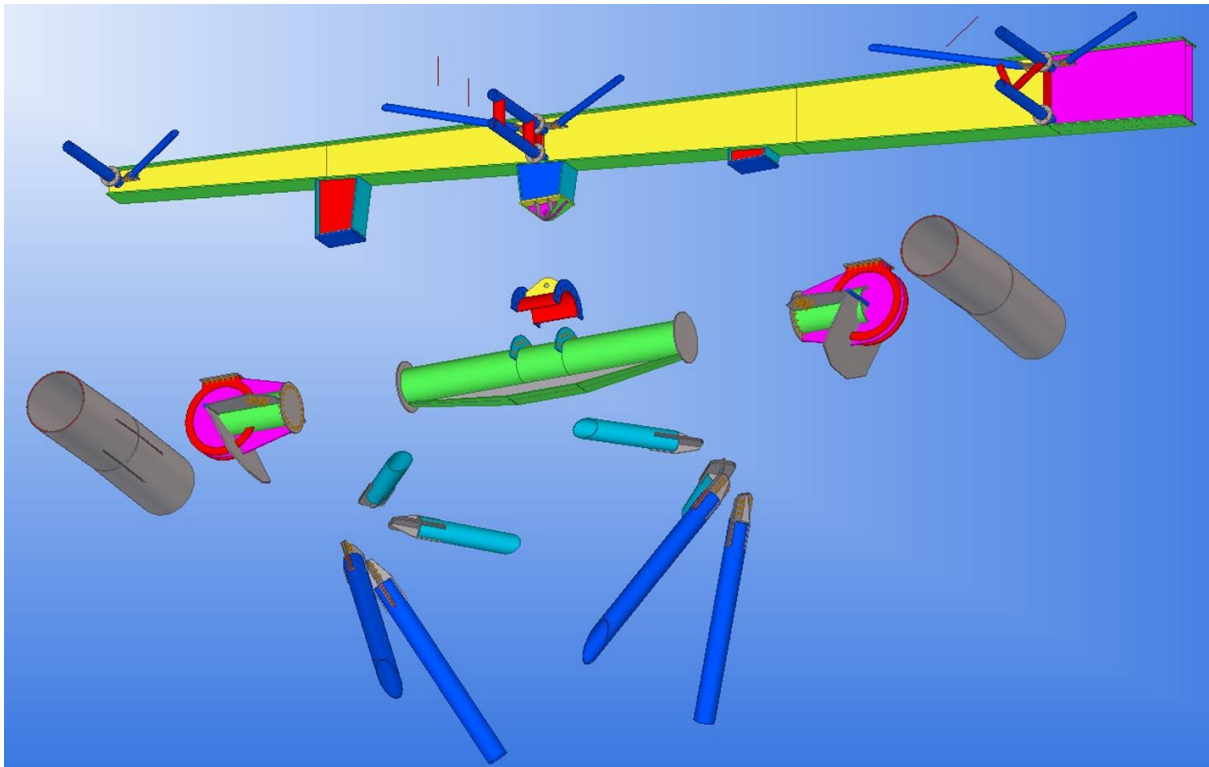



*Support of main beam on the truss*

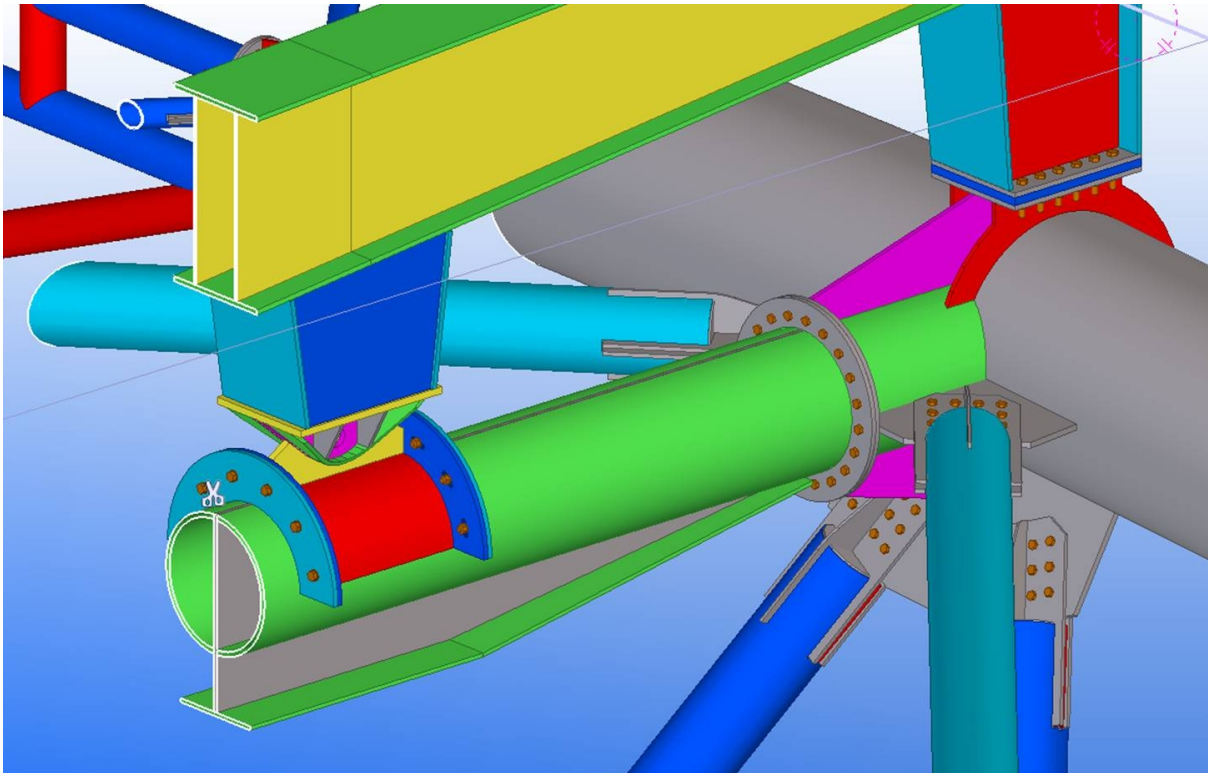



**DESIGN & APPLICATION ENGINEERS S.A.**  
ILEKTRAS 2 & KIMIS AVENUE, 15122 MAROUSSI  
TEL +30 (210)6412233, 2810122 FAX +30 (210)6454825  
e-mail: civeng@mhxme.gr web: www.mhxme.com

Einzelheiten



DATUM

03/07/2026

Pg

14/15

### Steel Roof General Arrangement

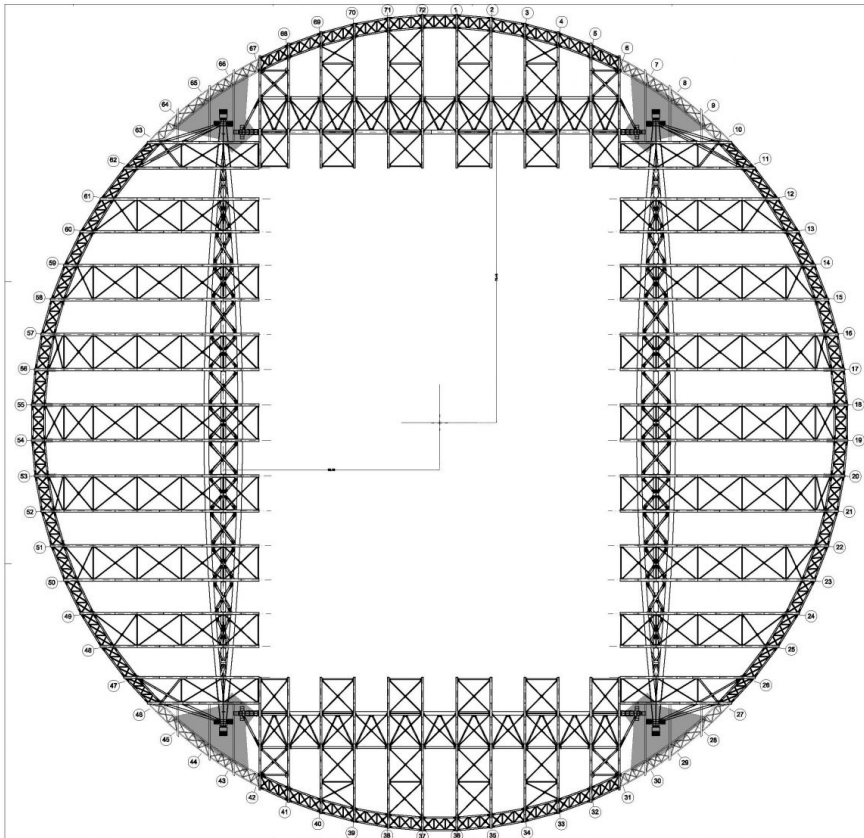



Sections

